



# Eskilo

Design: Tito Agnoli



**Poltrona Frau S.p.A.**

S.S. 77 Km 74,500 62029 Tolentino MC Italia

Tel +39 0733 9091 Fax +39 0733 971600 [info@poltronafrau.it](mailto:info@poltronafrau.it) [www.poltronafrau.it](http://www.poltronafrau.it)

### Eskilo 2 seater sofa

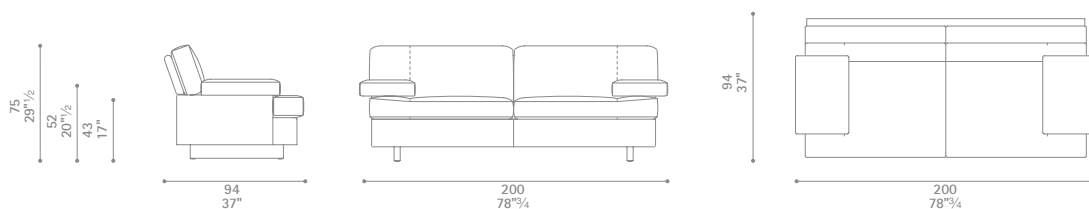

### Eskilo 2 seater large sofa

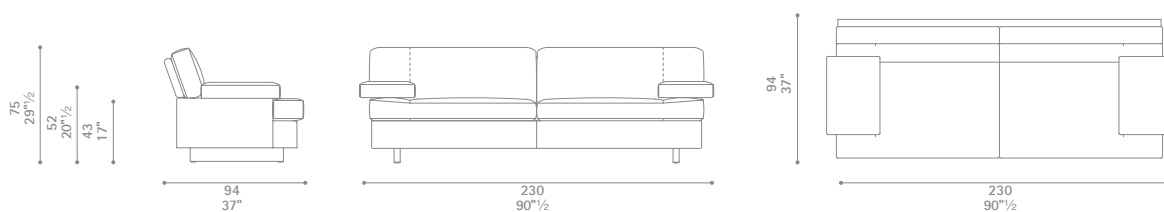

### Eskilo 3 seater sofa

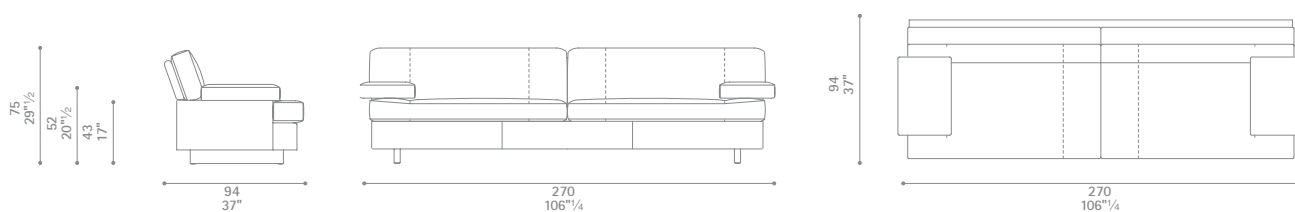

### Eskilo + 2 seater sofa

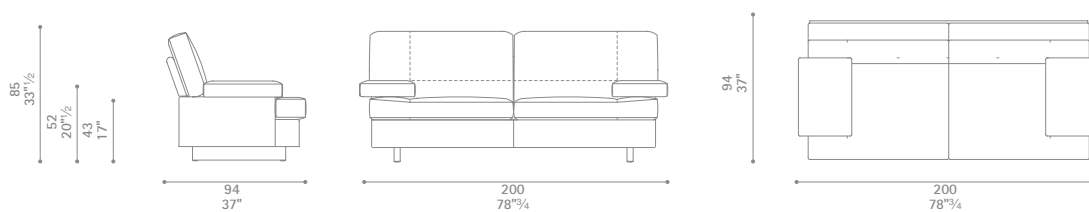

### Eskilo + 2 seater large sofa

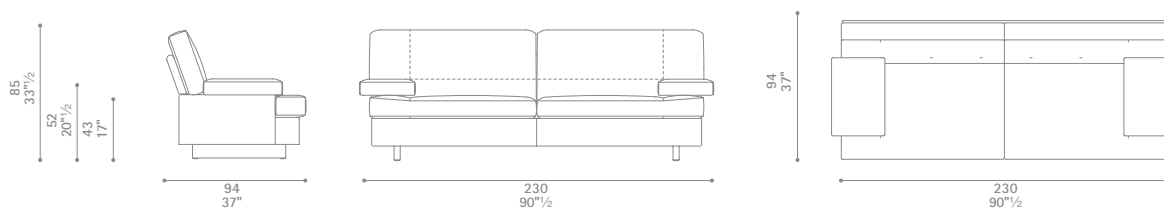

Dimensioni espresse in centimetri; sono possibili variazioni dimensionali del +/- 2%  
All dimensions and sizes are in centimetres, dimensional variations of +/- 2% are possible

**Poltrona Frau S.p.A.**

S.S. 77 Km 74,500 62029 Tolentino MC Italia

Tel +39 0733 9091 Fax +39 0733 971600 info@poltronafrau.it www.poltronafrau.it

### Eskilo + 3 seater sofa

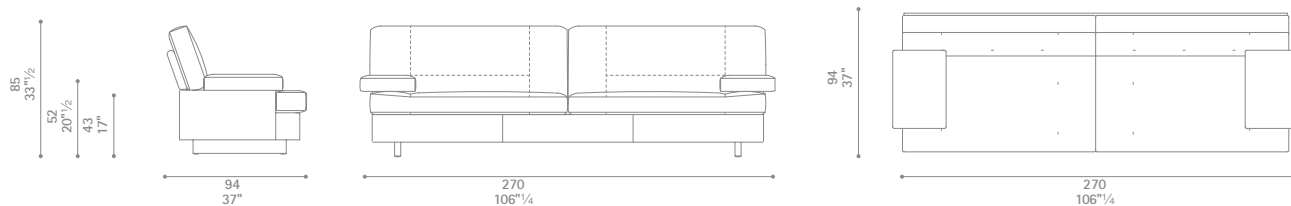

### Eskilo Sofa-bed

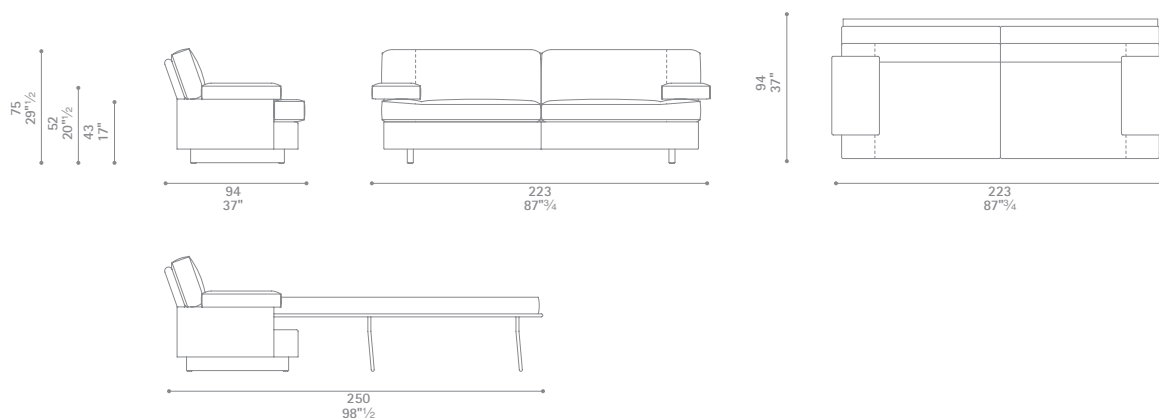

### Eskilo + Sofa-bed

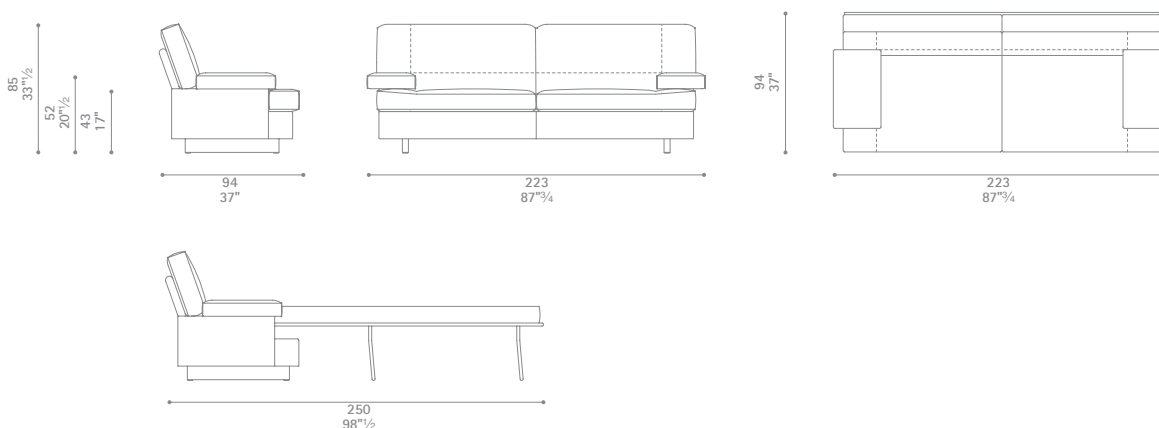

### Eskilo Pouf

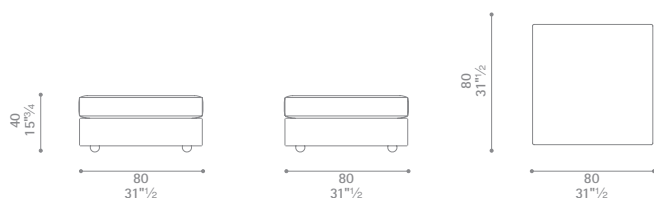

Dimensioni espresse in centimetri; sono possibili variazioni dimensionali del +/- 2%  
All dimensions and sizes are in centimetres, dimensional variations of +/- 2% are possible

**Poltrona Frau S.p.A.**

S.S. 77 Km 74,500 62029 Tolentino MC Italia

Tel +39 0733 9091 Fax +39 0733 971600 info@poltronafrau.it www.poltronafrau.it